

Migrating Exchange 2010

Mike Fawbush
Manager Technology and Networks
Morristown Utility Systems

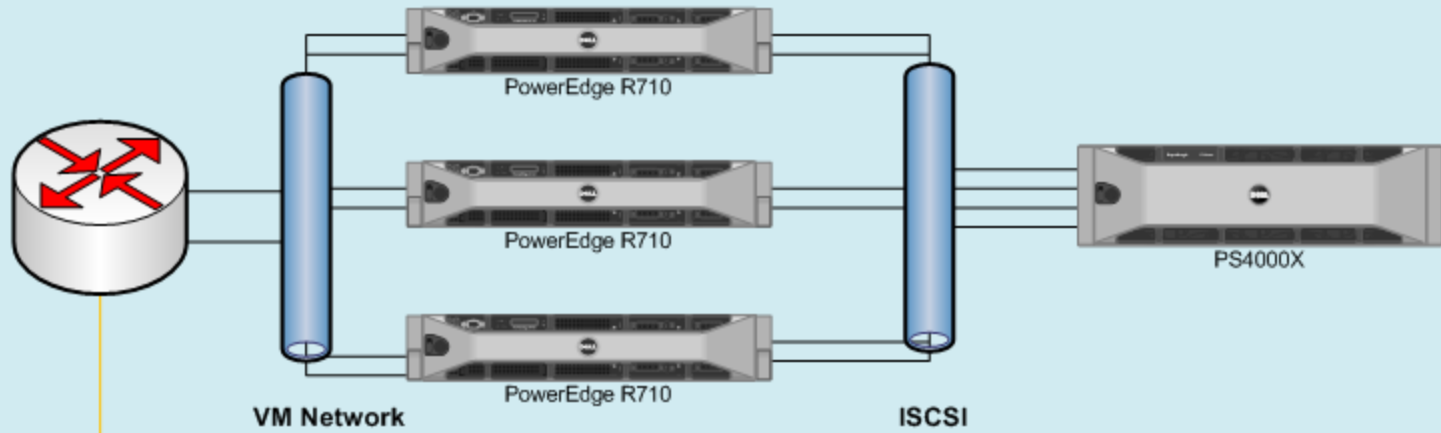

Main Office



10 G

Network Operation Center

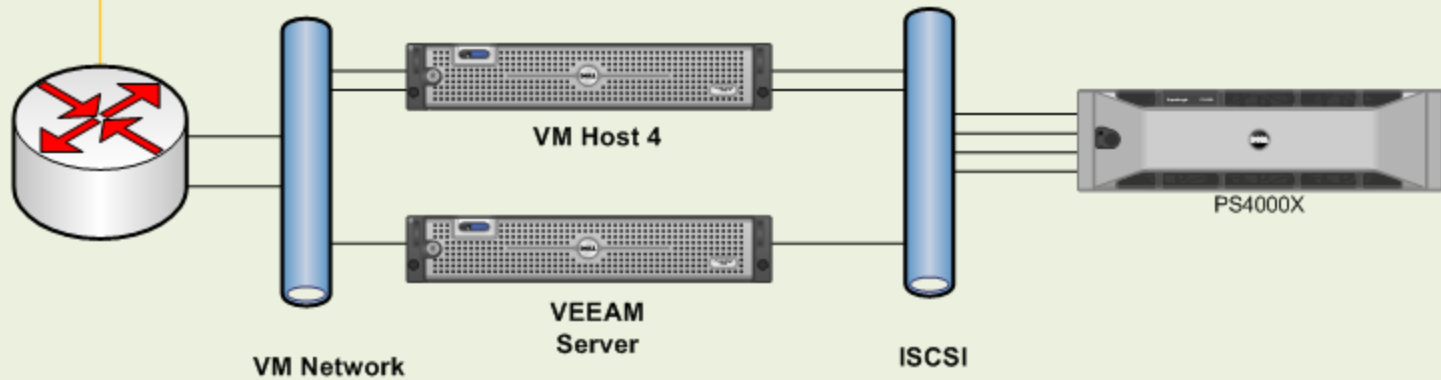

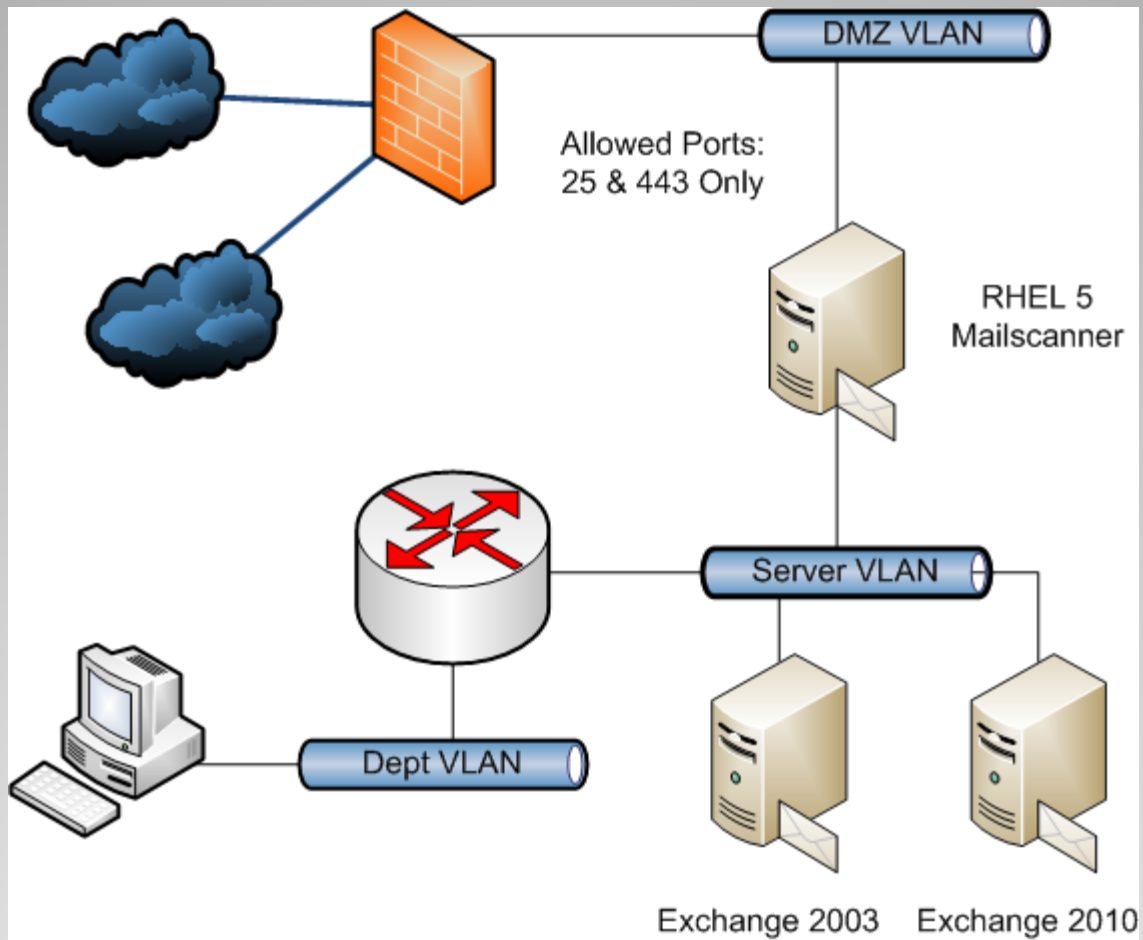

Exchange Layout

- Windows 2008 R2 Standard
- 8Gb Ram
- OS 40Gb
- Log 100Gb (Initially 40GB)
- Data 200Gb (Thin Provisioned)

2010 Server Specs

- Mailbox
- Client Access
- Hub Transport

Server Roles

<http://www.petenetlive.com/KB/Article/0000234.htm>



Resourced Used

CPU/Past month, 9/12/2011 7:56:13 AM - 10/12/2011 7:56:13 AM [Chart Options...](#)

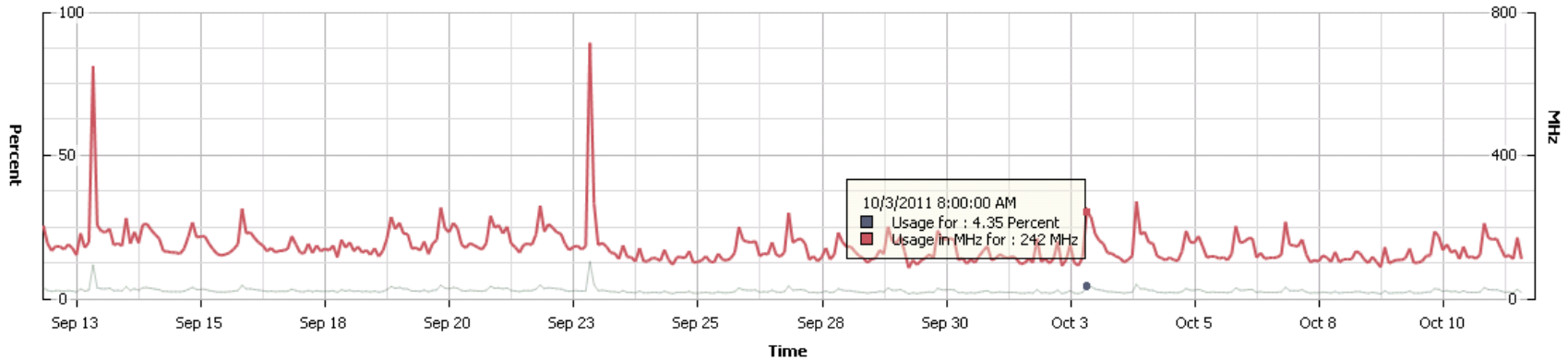
Switch to: CPU    



Performance Chart Legend

| Key | Object | Measurement | Rollup | Units | Latest | Maximum | Minimum | Average |
|---|------------|--------------|---------|---------|--------|---------|---------|---------|
|  | mail-2k8r2 | Usage | Average | Percent | 1.99 | 12.83 | 1.54 | 2.601 |
|  | mail-2k8r2 | Usage in MHz | Average | MHz | 110 | 716 | 85 | 144.5 |

CPU Performance

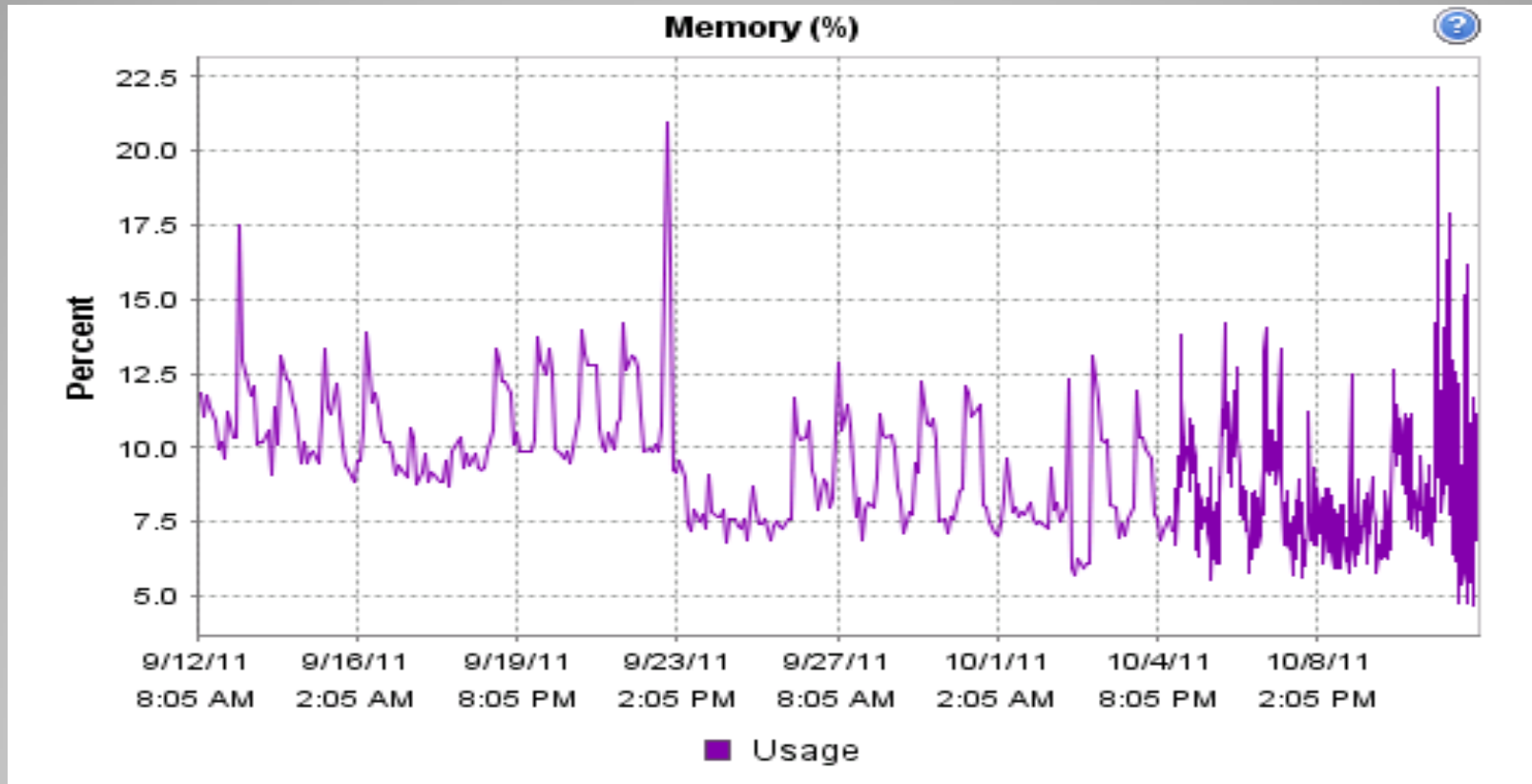

Memory Performance

- Mailbox Migration fill log files
- Aliases domains stop working
- Killed Smartphone access
- SSL Certs ,including root and intermediate
- Changed DNS Aliases
- 443 Forwarding on MailScanner
- Mailbox Size went back to default (1Gb)
- Outlook 2003 had internal cert errors

Other Actions

- Hub server don't relay and non trusted devices email by default
- Crashed IIS
- Corrupt mail boxes would not migrate
- Outlook 2003 cache mode errors
- PST Files Causing Lockups OL 2010

Other Actions (Continued)

- OWA
- Outlook 2010
- SMTP (Hub Transport)
- Management GUI
- Exchange 2010

Love/Hate



Questions?

- @ Dinner you're trying to remember what order Novell Netware drivers loaded
- Owned Apple IIC, Commodore 64, Tandy 1000
- You get into discussion on which had the best games
- You still have Atari 2600
- Know what Thick/Thin Net means
- Get into serious debate of the which linux distro is best

You Know You're OLD Geek If:

- You call a message a pedicure
- End you sentence with A
- Know how to set the IRQ and Base Address with Jumpers
- Know what EMM386 does
- If you have stayed up all night to see maybe 1 ³/₄ girly pictures from a BBS

You Know You're OLD Geek If: